

Centellis™ 2000, R1.0 & R2.0

AdvancedTCA Platform Core

■ Embedded Computing for
Business-Critical Continuity™

Flexible configurations and power options make the Centellis 2000 the ideal choice for both central office and data center applications

- Two-slot, 3U, 19" form factor (horizontal slots)
- Targeted for central office and data center environments
- Front-to-rear cooling - CP-TA B.4 compliant
- SpiderWare®M3 platform management software included
- Integrated shelf management and Base switching infrastructure
- Direct cross-connect circuitry for the Fabric Interface (1G/10G/40G)
- AC and DC power configurations available
- Simplex and duplex configurations available
- Two user slots for OEM customization
- RoHS 6/6 compliant
- Designed for NEBS/ETSI compliance (DC variants only)

The Emerson Network Power Centellis™ 2000 platform core is a high availability platform ideally suited for data intensive, central office and enterprise networking applications. The low profile makes the Centellis 2000 the optimal candidate for distributed networking functions, low density subscriber areas, or specialized applications. Target applications include distributed control plane functions, IMS/IPTV subsystems, 4G wireless applications, and edge networking and routing.

This compact platform integrates chassis, cooling, power distribution and shelf management into an off-the-shelf solution for small and medium size network element deployments. The small form factor AdvancedTCA® chassis enables reuse of existing, larger scale AdvancedTCA (ATCA®) hardware and software elements providing a significant reduction in development cost and reducing time-to-market for deployments.

The Centellis 2000 is available in simplex and duplex configurations with regard to power, shelf management and base interface switching. Further flexibility is achieved by offering both DC or AC power input modules. Future blade bandwidth requirements are addressed with a sophisticated 1G/10G/40G capable fabric cross-connect backplane. This will allow the simple upgrade of 40G ATCA blades when available without a chassis fork-lift upgrade.

Designed to meet NEBS and ETSI environmental requirements, the Centellis 2000 features front-to-rear cooling, and is designed to meet the stringent Communications Platform Trade Association (CP-TA) B.4 thermal profile. This superior cooling performance enables any combination of ATCA blades and rear transition modules (RTMs) within the ATCA specification limits.



AdvancedTCA®

EMERSON™
Network Power

Block Diagram with Two ATCA Blades

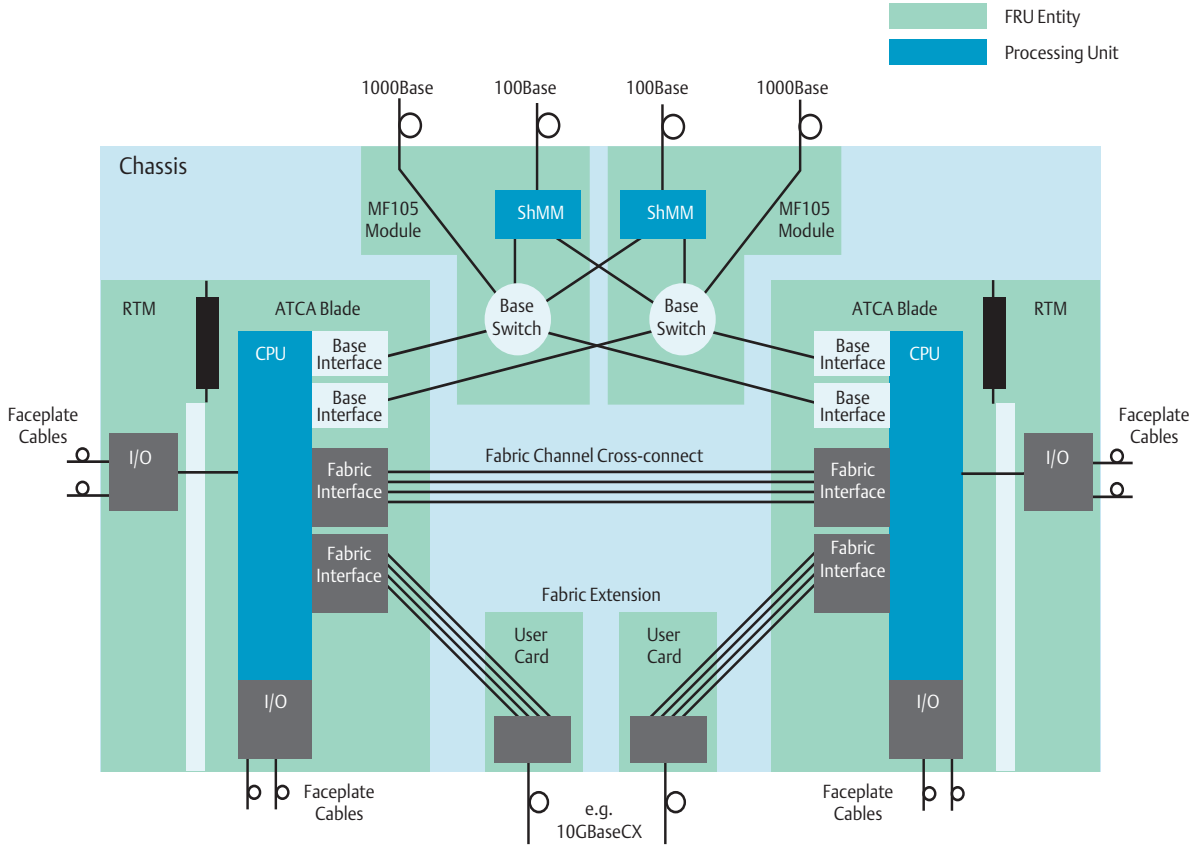

Shelf Overview

ENCLOSURE

- Two (2) slots for 8U AdvancedTCA blades
- Two (2) slots for 8U RTMs
- Two (2) user card slots for custom modules
- 40G backplane
- Front-to-rear cooling architecture
- ESD and earth ground points

ENCLOSURE DIMENSIONS

- Height – 132 mm
- Width – 445 mm
- Depth – 420 mm

Note – Dimension figures do not include mounting ears and cable trays unless specifically noted

PRODUCT WEIGHT

- CENT-2000-DCB: 12.70 lbs.
- CENT-2000-DC2B: 14.20 lbs.
- CENT-2000-AC: 12.74 lbs.
- CENT-2000-AC2: 14.28 lbs.

OPERATING ENVIRONMENT

- Operating temperature range (DC): -5 °C to 55 °C @ 90% non-condensing humidity
- Operating temperature range (AC): -5 °C to 50 °C @ 90% non-condensing humidity
- Storage temperature range: -40 °C to 70 °C @ 95% relative humidity

POWER REQUIREMENTS

- CENT-2000-DCB nominal/maximum: 29.9/153.1 Watts
- CENT-2000-DC2B nominal/maximum: 30.1/155.6 Watts
- CENT-2000-AC nominal/maximum: 32.1/176.2 Watts
- CENT-2000-AC2 nominal/maximum: 33.0/177.0 Watts

BACKPLANE

- Zone 1
 - ▲ Redundant, bussed IPMI to all blade slots
 - ▲ Redundant, bussed -48 VDC to all blade slots

- Zone 2
 - ▲ Dual star configuration for the base interface
 - ▲ Direct cross-connect routing between blade slots for fabric connectivity
 - ▲ Fabric Channel 2 of AdvancedTCA Slot 1 is routed to User Card 1
 - ▲ Fabric Channel 1 of AdvancedTCA Slot 2 is routed to User Card 2
 - ▲ Update channel routing for all slots
 - ▲ Three redundant, bussed telecom clock signals to all hub/node slots
 - ▲ Update channel routing
- Zone 3
 - ▲ PICMG 3.0 defined open area, application specific

* Fabric interface configurations support 1G, 10G and 40G operation

SHELF MANAGEMENT

- N+1 redundancy architecture
- Two (2) shelf management slots
- Integrated Base switch infrastructure

POWER DISTRIBUTION

- 2N redundancy architecture
- CENT-2000-DCB: One (1) power entry module (PEM) slot
- CENT-2000-DC2B: Two (2) PEM slots
- CENT-2000-AC: One (1) power supply unit (PSU) slot
- CENT-2000-AC2: Two (2) PSU slots

COOLING

- N+1 redundancy architecture
- Front-to-back cooling architecture
- Single (1) front/right fan tray module slot

RELEVANT STANDARDS

- PICMG 3.0 (form factor, IPMI, base interface, hot swap, RTM)
- PICMG 3.1, Options 1 and 9 (1G, 10G operation)
- PICMG 3.1 R2 (40G operation) – Future, pending specification release.
- CP-TA B.4

Shelf Layout

FRONT (TOP TO BOTTOM)

- Six (6) horizontal, 8U blade slots
- Front cable management system
- Two (2) vertical, Shelf Management Modules slots
- Four (4) power module slots (AC/DC)
- Air inlet area

REAR (TOP TO BOTTOM)

- Six (6) horizontal, 8U RTM slots
- Rear cable management system
- Telco Alarm interface (DB-15)
- Four (4) AC input receptacles
- Three (3) fan tray module slots
- Two (2) sets of DC input lugs

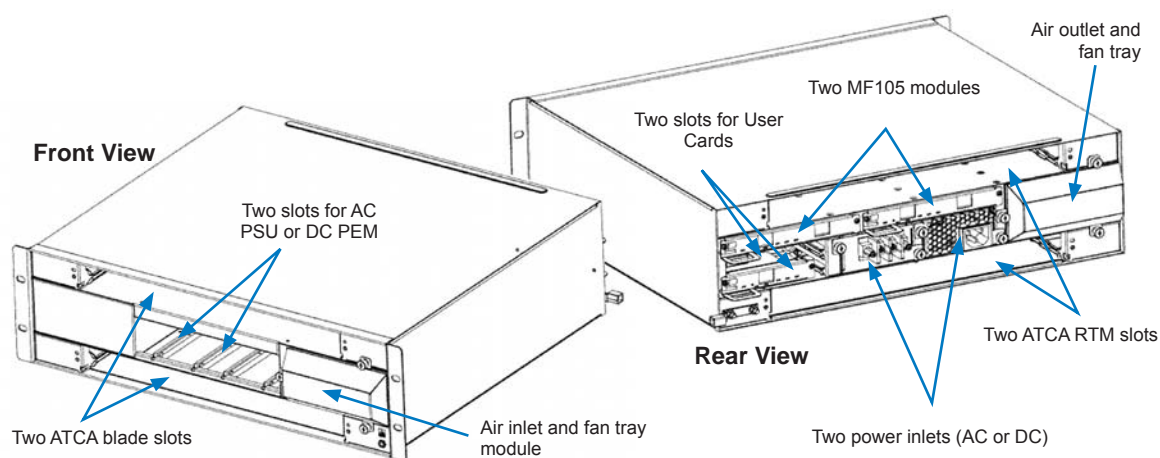

Shelf Management

The purpose of shelf management, as defined by the PICMG 3.0 standard, is to assure proper operation of AdvancedTCA blades and other components within the shelf. The shelf management module continually monitors all low-level, hardware functionality (inventory, sensor, status data, etc.) and reports status to the system manager. It also provides control access to these attributes. Management access to this information is provided via local console and Ethernet interfaces as well as the Service Availability™ Forum (SA Forum) defined HPI interface. Each blade and major shelf component has an Intelligent Platform Management Controller (IPMC) that is responsible for providing this information to the shelf management module. The Centellis 2000 provides redundant shelf management functionality utilizing an active/standby architecture. Visual indicators, as well as physical interfaces, are provided for direct front panel access.

The Base Interface switch functionality is integrated into the MF105 Shelf Management module. The switch infrastructure supports IEEE 802.3 1000BASE-T,

100BASE-TX, 10BASE-T connectivity to both AdvancedTCA slots as required by PICMG 3.0. One external 1000BASE-T Ethernet interface is available on the face plate for external connectivity.

PROCESSOR

- Freescale MPC852T @ 100 MHz

MEMORY

- 64MB, DDR2 SDRAM
- 64MB boot flash, single-bank architecture

PANEL ACCESS & INTERFACES

- One (1) 1.0G Base Interface port, RJ-45
- One (1) 10/100BaseT management Ethernet, RJ-45

SHELF MANAGER LED STATUS INDICATORS

- In service (OK)
- Out of service (OOS)
- ACT (Activity Shelf Manager)
- Link (Ethernet link/activity)

Fan Tray Module

The Centellis 2000 utilizes a fault-tolerant, push-pull cooling architecture and is implemented using front and rear fan tray modules. The cooling system is designed to provide CP-TA B.4 cooling performance for the most demanding, next generation packet processing based ATCA blades. An integrated shelf manager function monitors and controls the speed of each individual fan for optimal performance. Fan control decisions are made based on air intake temperature, air exhaust temperature and thermal data provided by the blades. In the event of communication failure between the shelf management entity and the fan tray modules, all fans automatically run at full speed to ensure maximum cooling until the failure is eliminated.

GENERAL CHARACTERISTICS

- CP-TA B.4 compliant cooling architecture
- Front-to-back cooling architecture
- Front blade cooling capacity: 40 cubic feet per minute (CFM) at 55 °C
- RTM cooling capacity: 5 CFM at 55 °C
- Automatic fan speed control

Power Entry Module (PEM)

Power conditioning for the DC variant of the Centellis 2000 shelf is provided by one or two PEMs. They provide power to the backplane on the redundant -48 VDC power rails for blades, RTMs and other shelf components. The actual power connection is located in the rear of the chassis and for safety reasons is a fixed, non-field replaceable unit.

GENERAL CHARACTERISTICS

- Input voltage range (-40 VDC to -72 VDC)
- 30 amp (max.), single-feed design
- Power infrastructure capable of supporting up to 350 Watts/slot
- EMI filtering
- Transient voltage suppression

LED STATUS INDICATORS

- Reverse (polarity detection)
- In (Input power available)
- Backplane (power available to the backplane)

Power Supply Unit (PSU)

Power conditioning for the AC variants of the Centellis 2000 shelf is provided by two or four AC PSUs. Standard AC receptacles are provided for simple installation; the PSU output provides DC power to the backplane on the redundant -48 VDC power rails for blades, RTMs and other shelf components. The actual power connection is located in the rear of the chassis and for safety reasons is a fixed, non-field replaceable unit.

GENERAL CHARACTERISTICS

- Input voltage range (100 - 240 VAC, 50/60Hz @ 8.5 amps)
- Power infrastructure capable of supporting up to 350 Watts/slot
- EMI filtering
- Transient voltage suppression

LED STATUS INDICATORS

- Status (red/green)

User Cards

Two User Card slots are provided to allow customers the ability to integrate custom functions into the platform. Examples include Telecom clock generators, 10GB fabric uplinks, or telecom alarms. Each User Card is 110 mm deep x 70 mm wide x 20 mm high and accesses redundant power, IPMC, and clock connections and fabric channel connectivity.

GENERAL CHARACTERISTICS

- Two (2) slots for User Cards in the rear of chassis
- Direct connection to backplane:
 - ▲ Redundant -48 V power
 - ▲ Redundant intelligent peripheral management controllers (IPMC)
 - ▲ Redundant CLK1, CLK2 and CLK3
 - ▲ One fabric channel to one ATCA blade (Four LVDS ports)

Software

SpiderWare®M³ platform management software is included with the Centellis 2000 platform core. SpiderWareM³ runs on Linux and can be hosted locally (on a payload blade) or externally. See the SpiderWareM³ data sheet for more details.

| Ordering Information | |
|--|--|
| Product | Description |
| Platform Core Products | |
| CENT-2000-DC | 2-slot ATCA chassis, 1X DC PEM, 1X MF105 SHMM (Silver) |
| CENT-2000-DC2 | 2-slot ATCA chassis, 2X DC PEM, 2X MF105 SHMM (Silver) |
| CENT-2000-DCB | 2-slot ATCA chassis, 1X DC PEM, 1X MF105 SHMM (Black) |
| CENT-2000-DC2B | 2-slot ATCA chassis, 2X DC PEM, 2X MF105 SHMM (Black) |
| CENT-2000-AC | 2-slot ATCA chassis, 1X AC PSU, 1X MF105 SHMM (Black) |
| CENT-2000-AC2 | 2-slot ATCA chassis, 2X AC PSU, 2X MF105 SHMM (Black) |
| Optional Platform Core Products | |
| CENT-2000-UC-10GE | CENT-2000 user card with 10G port (SFPP module not included) |
| C2000-UC-TA-10GE | CENT-2000 user card with 10G port (SFPP module not included) & Telco Alarm |
| CENT-2000-UFP | CENT-2000 user card filler panel |
| CENT-2000-PFP | CENT-2000 PEM/PSU filler panel - Silver |
| CENT-2000-PFP-B | CENT-2000 PEM/PSU filler panel - Black |
| C2000-SWM3-CD | CENT-2000 SpiderWare®M ³ management software CD |
| C2000-RKMT-M | CENT-2000 19/23" frame mid mounting bracket kit (set of 4) |
| C2000-RKMT-E | CENT-2000 ETSI 600MM frame mounting bracket kit |
| C2000-RKMT-A | CENT-2000 ANSI 24" frame mounting bracket kit |
| C2000-RKMT-23 | CENT-2000 23" frame mounting bracket kit |
| C2000-CBLTR | CENT-2000 cable tray bracket (one unit) |
| AXP-F-FILL-PANEL | Blank filler panel, AXP1620, AXP1440, AXP1410, C2000 - Front |
| AXP-R-FILL-PANEL | Blank filler panel, AXP1620, AXP1440, AXP1410, C2000 - Rear |
| AC-PC-15A-US | AC power cord, 15 Amps, 125 Volts, US & Canada connector |
| AC-PC-15A-AUS | AC power cord, 15 Amps, 250 Volts, Australia & New Zealand connector |
| AC-PC-15A-UK | AC power cord, 15 Amps, 250 Volts, UK connector |
| AC-PC-15A-EU | AC power cord, 15 Amps, 250 Volts, EU connector |
| AC-PC-15A-JAP | AC power cord, 15 Amps, 125 Volts, Japan connector |
| FRUs | |
| CENT-2000-PEM | CENT-2000 DC power entry module - Silver |
| CENT-2000-PEM-B | CENT-2000 DC power entry module - Black |
| CENT-2000-MF105 | CENT-2000 M100 style SHMM module with integrated Base switch |
| CENT-2000-FFTM | CENT-2000 front fan tray module - Silver |
| CENT-2000-FFTM-B | CENT-2000 front fan tray module - Black |
| CENT-2000-RFTM | CENT-2000 rear fan tray module |
| CENT-2000-PSU | CENT-2000 AC power supply unit - Black |
| CENT-2000-SFM | CENT-2000 replacement air filter (one unit) |

| Regulatory Compliance | |
|---|--|
| Item | Description |
| Designed to comply with NEBS (DC variants only) | Telcordia GR-63-CORE, NEBS Physical Protection, Level 3 |
| | Telcordia GR-1089-CORE, Electromagnetic Compatibility and Electrical Safety— Generic Criteria for Network Telecommunications Equipment. Level 3, Equipment Type 2 |
| Designed to comply with ETSI | ETSI Storage, ETS 300 019-2-1, Class 1.2 equipment, Weatherprotected, not Temperature Controlled Storage Locations |
| | ETSI Transportation, ETS 300 019-1-2, Class 2.3 equipment, Public Transportation |
| | ETSI Operation, ETS 300 019-1-3, Class 3.1(E) equipment, Partly Temperature Controlled Locations |
| | ETSI EN 300-132-2 Environmental Engineering (EE); Power supply interface at the input to telecommunications equipment; Part 2: Operated by direct current (dc) |
| | ETS-300-753, Equipment Engineering (EE); Acoustic noise emitted by telecommunications equipment |
| EMC | ETSI EN 300 386 Electromagnetic compatibility and Radio spectrum Matters (ERM); telecommunication network equipment; ElectroMagnetic Compatibility (EMC) requirements, Telecommunication equipment room (attended) |
| | FCC 47 CFR Part 15 Subpart B (US), Class A |
| | ECISPR 22, Limits and Methods of Measurement of Radio Disturbance Characteristics of Information Technology Equipment |
| | AS/NZS CISPR 22 (Australia/New Zealand), Limits and Methods of Measurement of Radio Disturbance Characteristics of Information Technology Equipment |
| | VCCI Class A (Japan), Voluntary Control Council for Interference by Information Technology Equipment |
| | Industry Canada ICES-003 Class A |
| Safety | Compliance to UL/CSA 60950-1, EN 60950-1 and IEC 60950-1 CB Scheme. Marked with U.S. NRTL, Canadian Safety and CE Mark. |
| RoHS/WEEE compliance | DIRECTIVE 2002/95/EC OF THE EUROPEAN PARLIAMENT AND OF THE COUNCIL on the restriction of the use of certain hazardous substances in electrical and electronic equipment (RoHS) |
| | DIRECTIVE 2002/96/EC OF THE EUROPEAN PARLIAMENT AND OF THE COUNCIL on waste electrical and electronic equipment (WEEE) |
| CE Conformity | Directive 2004/108/EC, Directive 2006/95/EC |













SOLUTION SERVICES

Emerson Network Power provides a portfolio of solution services optimized to meet your needs throughout the product lifecycle. Design services help speed time-to-market. Deployment services include global 24x7 technical support. Renewal services enable product longevity and technology refresh.

PICMG, AdvancedTCA and the AdvancedTCA logo are registered trademarks of the PCI Industrial Computer Manufacturers Group. PowerPC is a trademark of IBM Corp. and used under license. Intel, Pentium, Xeon and Core are registered trademarks of Intel Corporation or its subsidiaries in the U.S. and other countries. All other product or service names are the property of their respective owners.

This document identifies products, their specifications, and their characteristics, which may be suitable for certain applications. It does not constitute an offer to sell or a commitment of present or future availability, and should not be relied upon to state the terms and conditions, including warranties and disclaimers thereof, on which Emerson Network Power may sell products. A prospective buyer should exercise its own independent judgment to confirm the suitability of the products for particular applications. Emerson Network Power reserves the right to make changes, without notice, to any products or information herein which will, in its sole discretion, improve reliability, function, or design. Emerson Network Power does not assume any liability arising out of the application or use of any product or circuit described herein; neither does it convey any license under its patent or other intellectual property rights or under others. This disclaimer extends to any prospective buyer, and it includes Emerson Network Power's licensee, licensee's transferees, and licensee's customers and users. Availability of some of the products and services described herein may be restricted in some locations.

Emerson Network Power.
The global leader in enabling
Business-Critical Continuity™.

-  AC Power
-  Embedded Power
-  Precision Cooling
-  Connectivity
-  Infrastructure Management & Monitoring
-  Racks & Integrated Cabinets
-  DC Power
-  Outside Plant
-  Services
-  Embedded Computing
-  Power Switching & Controls
-  Surge Protection

Emerson Network Power

Offices: Tempe, AZ U.S.A. 1 800 759 1107 or +1 602 438 5720
 Paris, France +33 1 60 92 31 20 • Munich, Germany +44 1509 236490 • Tel Aviv, Israel +972 99560361
 Hong Kong +852 2176 3540 • Shanghai, China +86 21 3395 0289 • Tokyo, Japan +81 3 5403 2730 • Seoul, Korea +82 2 3483 1500

EmersonNetworkPower.com/EmbeddedComputing

Emerson, Business-Critical Continuity and Emerson Network Power are trademarks of Emerson Electric Co. or one of its affiliated companies. ©2011 Emerson Electric Co.